



MOMO 2237 Monitor Arm Motion for 2 monitors (white)

Key Benefits

- Height Adjustable
- Suitable for one, two or a whole series of monitors
- Easy install
- Flexible modular system
- TÜV certified / 10-year guarantee

The ergonomic monitor arm for every workplace The MOMO 2237 is a monitor arm specially designed for two height-adjustable monitors. The monitor arm is suitable for monitors up to 34 inches and weighing up to 20 kg.

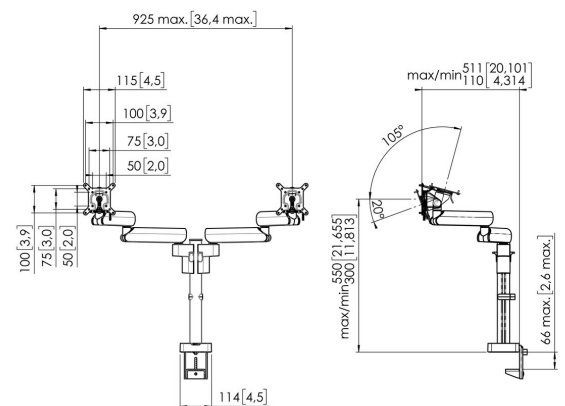



MOMO 2237 Monitor Arm Motion for 2 monitors (white)

Specifications

Min. screen size (inch)	10
Max. screen size (inch)	34
Max. screen size (inch)	34
Universal or fixed hole pattern	Fixed
Max. height of interface (mm)	115
Max. width of interface (mm)	115
Max. display width (mm)	925
Max. weight load (kg)	20
Max. weight load (Lbs)	44.09
Max. center display	550
Max. thickness desk	66
Turn	Up to 180°
Number of pivot points	3
Rotate	Up to 180°
Tilt	Tilt -20°/+105°
Height adjustment	Manual operated
Adjustable depth	Yes
Adjustable height	Yes
Mounting Possibilities	On and through desk
Article number (SKU)	7122371
EAN single box	8712285353888
Colour	White
TÜV certified	Yes
Guarantee	10 years

VOGEL'S HOLDING BV (©)

All rights reserved.
Subject to printing errors,
technical and price
amendments.

Date: 2024-03-25

